



PROUDLY  
SERVING THE  
OPTICAL  
INDUSTRY SINCE  
2004

MANUFACTURER OF HIGH QUALITY  
QUARTZ CRYSTALS.  
SUPPLIER OF THIN FILM & AR  
CONSUMABLES FROM STOCK!!



5 & 6 MHz QUARTZ  
MONITOR CRYSTALS  
(PAGE 2 & 3)

OPTINAL<sup>®</sup>  
EVAPORATION MATERIALS,  
SUPER HYDROPHOBIC TOP COAT  
TABLETS, & AR CHEMICALS  
(BACK PAGE)

EBEAM EMITTER PARTS  
(PAGE 4)

**SUPERCLEAN**  
UHV CHAMBER FOIL & FOIL DISPENSING STANDS  
(PAGE 5)

CRYSTAL SENSOR HEADS, FEEDTHRUS & CABLES (PAGE 6)

SENSOR HEAD SPARE PARTS (PAGE 6)

EBEAM GUN/ION GUN FILAMENTS (PAGE 7)

MARK I & MARK II  
ION SOURCE PARTS (PAGE 7)

PHONE: 970-674-XTAL(9825)  
FAX: 970-674-9826  
EMAIL: SALES@THINFILMSUPPLY.COM

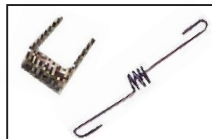
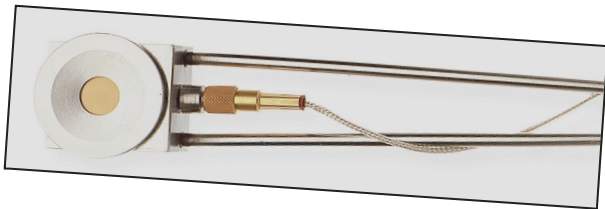

**PICK YOUR SLICK**

**HYDRO & SUPER HYDRO TOP COAT TABLETS**

(BACK PAGE)

# HIGH QUALITY QUARTZ

## 6 MHZ QUARTZ MONITOR CRYSTALS FOR:

## INFICON/FILTECH/MAXTEK/SIGMA/SYCON/INTELLEMETRICS

PACKAGED IN SPECIALLY  
DESIGNED  
ANTI-STATIC CAROUSELS

GREAT FOR METALLIZATION



FOR STRESSFUL OPTICAL COATINGS



### AT CUT, .550" DIAMETER, PLANO/CONVEX REPLACEMENT QCM SENSOR CRYSTALS

PART NUMBER	GUARANTEED TO REPLACE...	FREQUENCY	ELECTRODE MATERIAL	ADHESION LAYER	PRICE
ASC-010G	FILTECH PART# QJ8010 INFICON PART# 008-010 MAXTEK PART# SC-101	6 MHZ	GOLD (AU)	CHROMIUM (CR)	\$40. 10 PC. PKG.
ASC-003A	FILTECH PART# QJ8008 INFICON PART# 750-679-G1 MAXTEK PART# 103240	6 MHZ	ALLOY	*NONE	\$40. 10 PC. PKG.
ASC-001S	FILTECH PART# QJ8009 INFICON PART# 008-009 MAXTEK PART# SC-102	6 MHZ	SILVER (AG)	CHROMIUM (CR)	\$40. 10 PC. PKG.



**DIRECT FROM OUR FACTORY!**  
**MADE IN THE USA!**

### 5.98 MHZ QUARTZ MONITOR CRYSTALS FOR SATIS

PART NUMBER	GUARANTEED TO REPLACE...	FREQUENCY	ELECTRODE MATERIAL	ADHESION LAYER	PRICE
ASC-010G-SAT	SATIS PART# 7500448N018	5.98 MHZ	GOLD (AU)	CHROMIUM (CR)	\$40. 10 PC. PKG.
ASC-003A-SAT	SATIS PART# 7500448N022	5.98 MHZ	ALLOY	*NONE	\$40. 10 PC. PKG.

TEL **970-674-9825**

# MONITOR CRYSTALS





+ 100% TESTING = HIGHEST QUALITY CRYSTALS

EACH CRYSTAL IS TESTED FOR THE PROPER ELECTRICAL, COSMETIC, AND ACTIVE PROPERTIES. 100% TESTING IS THE ONLY WAY TO ENSURE THAT YOU ARE GETTING A RELIABLE SENSOR. WE ARE PROUD TO SAY THAT WE GUARANTEE OUR CRYSTALS. IF YOU ARE NOT SATISFIED, SIMPLY RETURN THEM TO US FOR CREDIT OR REPLACEMENT.



## 5 MHz QUARTZ MONITOR CRYSTALS-*BALZER STYLE*

**AT CUT, .550" DIAMETER, PLANO/CONVEX REPLACEMENT QCM SENSOR CRYSTALS, 1/2 ANCHOR**

PART NUMBER	GUARANTEED TO REPLACE...	FREQUENCY	ELECTRODE MATERIAL	ADHESION LAYER	PRICE
 ASC-01BG	FILTECH PART# QB104G MAXTEK PART# SC-152 UMICORE PART# UN845-104-T	5 MHz	GOLD (AU)	CHROMIUM (CR)	\$43. 10 PC. PKG.
 ASC-01BA	FILTECH PART# QB104A MAXTEK PART# N/A UMICORE PART# N/A	5 MHz	ALLOY	*NONE	\$43. 10 PC. PKG.
 ASC-01BS	FILTECH PART# QB104S MAXTEK PART# SC-153 UMICORE PART#BN845-104-T	5 MHz	SILVER (AG)	CHROMIUM (CR)	\$43. 10 PC. PKG.

## 5 MHz QUARTZ MONITOR CRYSTALS-*SLOAN/ULVAC*

**AT CUT, .490" DIAMETER, PLANO/CONVEX REPLACEMENT QCM SENSOR CRYSTALS, COATED BOTH**

PART NUMBER	GUARANTEED TO REPLACE...	FREQUENCY	ELECTRODE MATERIAL	ADHESION LAYER	PRICE
 ASC-01SG	FILTECH PART# QS3952 MAXTEK PART# 186201	5 MHz	GOLD (AU)	CHROMIUM (CR)	\$43. 10 PC. PKG.
 ASC-01SA	FILTECH PART# QS3954 MAXTEK PART# N/A	5 MHz	ALLOY	*NONE	\$43. 10 PC. PKG.
 ASC-01SS	FILTECH PART# QS3950 MAXTEK PART# 186202	5 MHz	SILVER (AG)	CHROMIUM (CR)	\$43. 10 PC. PKG.

[WWW.SALES@THINFILMSUPPLY.COM](http://WWW.SALES@THINFILMSUPPLY.COM)

# ORDER ONLINE & GET **FREE SHIPPING** AT...

## E-BEAM REPLACEMENT PARTS FOR TEMESCAL/TELEMARK/LEYBOLD/CHA

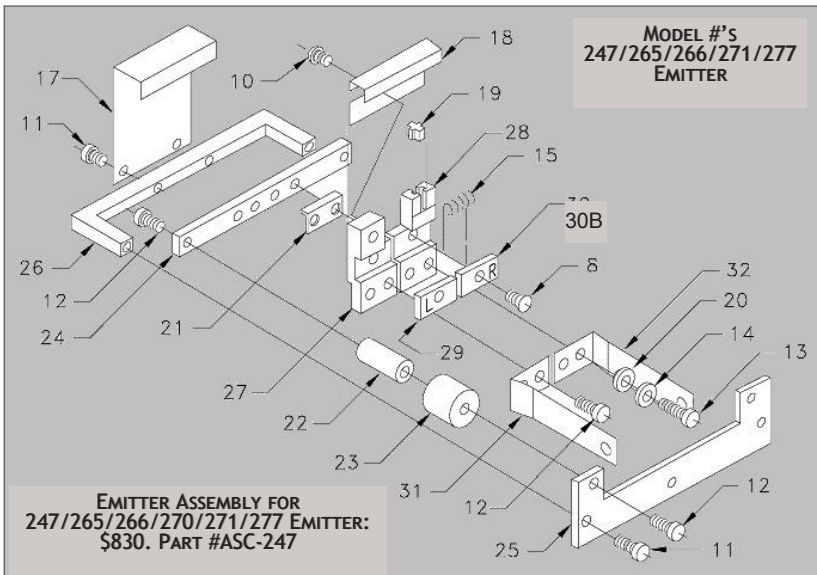
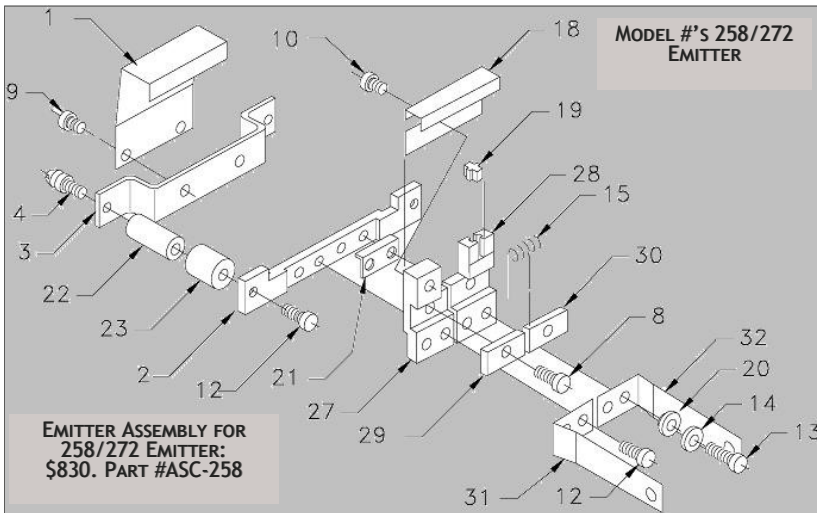
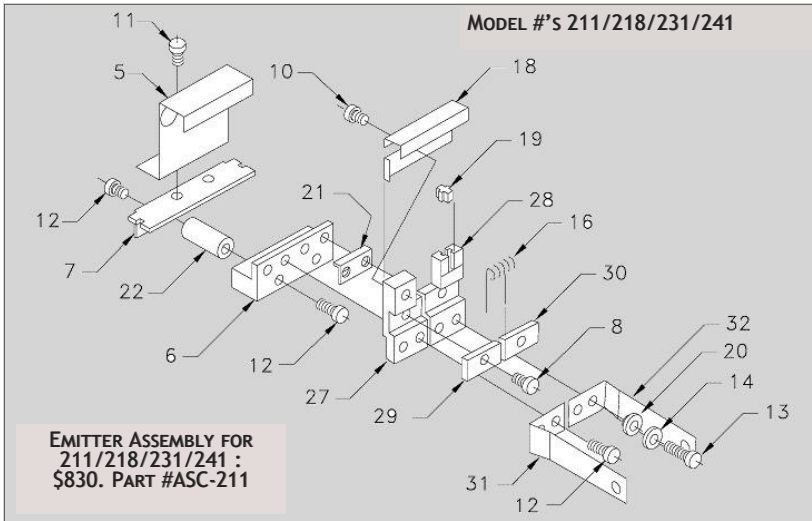

ITEM #	PART #	DESCRIPTION	PRICE
1	ASC-EB01	ANODE PLATE	\$60.
2	ASC-EB02	MOUNTING BRACKET	\$65.
3	ASC-EB03	SUPPORT BRACKET	\$70.
4	ASC-EB04	MOUNTING SCREW	\$25.
5	ASC-EB05	ANODE PLATE	\$70.
6	ASC-EB06	MOUNTING BRACKET	\$60.
7	ASC-EB07	SUPPORT BRACKET	\$120.
8	ASC-EB08	FLAT HEAD SLOT SCREW, #6-32 X 1/4" SS	\$5.
9	ASC-EB09	SOCKET HEAD CAP SCREW, #6-32 X 3/16" STAINLESS STEEL (BOX OF 10)	\$10
10	ASC-EB10	SOCKET HEAD CAP SCREW, #6-32 X 3/16" SS	\$5.
11	ASC-EB11	SOCKET HEAD CAP SCREW, #6-32 X 1/4" STAINLESS STEEL (BOX OF 10)	\$10.
12	ASC-EB12	SOCKET HEAD CAP SCREW, #6-32 X 3/8" STAINLESS STEEL (BOX OF 10)	\$10.
13	ASC-EB13	SOCKET HEAD CAP SCREW, #6-32 X 1/2" STAINLESS STEEL (BOX OF 10)	\$10.
14	ASC-EB14	FLAT WASHER, #6 STAINLESS STEEL (BOX OF 10)	\$10.
15	ASC-E75T	FILAMENT, 7.5 TURNS (BOX OF 5)	\$48.
16	ASC-EB16	FILAMENT, 5 TURN (BOX OF 5)	\$50.
17	ASC-EB17	ANODE PLATE	\$73.
18	ASC-EB18	BEAM FORMER	\$58.
19	ASC-EB19	INSULATOR, CROSS	\$10.
20	ASC-EB20	INSULATOR, COLLAR	\$10.
21	ASC-EB21	INSULATOR, L	\$20.
22	ASC-EB22	INSULATOR, HIGH VOLTAGE (BOX OF 10)	\$90.
23	ASC-EB23	HIGH VOLTAGE SHIELD (BOX OF 2)	\$20.
24	ASC-EB24	MOUNTING BRACKET	\$40.
25	ASC-EB25	EMITTER SUPPORT BRACKET	\$50.
26	ASC-EB26	U-BRACKET	\$65.
27	ASC-EB27	CATHODE BLOCK, LEFT	\$142.
28	ASC-EB28	CATHODE BLOCK, RIGHT	\$142.
30B	ASC-EB2930	INTERCHANGEABLE FILAMENT CLAMP R OR L (NO COUNTERSINK)	\$42.
31	ASC-EB31	FILAMENT BUS BAR, LEFT	\$40.
32	ASC-EB32	FILAMENT BUS BAR, RIGHT	\$40.

## ULTRA-HIGH VACUUM READY ALUMINUM CHAMBER FOIL

**COMPLETELY OIL-FREE!**  
**THIS FOIL IS SPECIALLY MADE**  
**TO BE USED INSIDE OF**  
**YOUR VACUUM SYSTEM.**  
**2 STOCK SIZES ALWAYS READY TO**  
**SHIP**  
**(SEE BELOW)**



PART NUMBER	MATERIAL	ROLL WIDTH	THICKNESS	LINEAR FEET	CORE	PACKAGING	WEIGHT	PRICE
ASC-1518F	1145-0 ALUMINUM	18"	.0015"	500'	PLASTIC	BOXED ROLL WRAPPED IN PLASTIC	16 LBS.	\$215./ROLL
ASC-3024F	1145-0 ALUMINUM	24"	.0030"	500'	PLASTIC	BOXED ROLL WRAPPED IN PLASTIC	42 LBS.	\$385./ROLL

**BENCH-TOP MOUNTABLE OR FREESTANDING**

**STEEL CONSTRUCTION WITH DURABLE PAINTED FINISH**

**SPECIAL TURNTABLE DESIGN MAKES IT EASY TO UNROLL YOUR REQUIRED LENGTH**

**STAND WORKS WITH EITHER SIZE ROLL**



**ADD A HANDY BENCH TOP FOIL DISPENSING STAND PART # ASC-FBTS**

**ONLY \$150.**

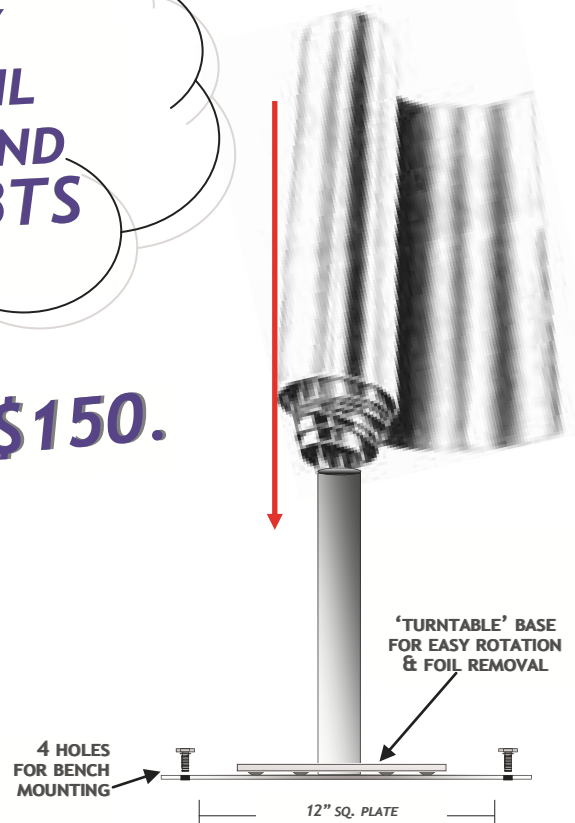

# SENSOR HEADS, FEEDTHROUGH, & CABLES



**IN-VACUUM CABLES FOR SENSOR HEADS**

ASC-IVS3

\$145./EA.

*\*30" STRANDED SILVER JACKET VACUUM TESTED CABLE*

## SINGLE SENSOR HEADS

PART#	DESCRIPTION	DIAGRAM	H2O LINES	COAXIAL LINES	AIR SHUTTER LINE?	PRICE
ASC-SH1	STRAIGHT SINGLE CRYSTAL SENSOR (30" LENGTH)		1/8" SS WELDED LINES (2)	1	No	\$500.
ASC-RA1	RIGHT ANGLE SINGLE CRYSTAL SENSOR (30" LENGTH)		1/8" SS WELDED LINES (2)	1	No	\$570.

## DUAL SENSOR HEAD

PART#	DESCRIPTION	DIAGRAM	H2O LINES	COAXIAL LINES	AIR SHUTTER LINE?	PRICE
ASC-SH2	STRAIGHT DUAL CRYSTAL SENSOR WITH SHUTTER (30" LENGTH)		1/8" SS WELDED LINES (2)	2	YES	\$1875.

## 1" BOLT FEEDTHRU

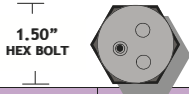

PART#	DESCRIPTION	DIAGRAM	H2O LINES	COAXIAL LINES	AIR SHUTTER LINE?	PRICE
ASC-BT1	SINGLE 1" BOLT FEEDTHRU (USE WITH SINGLE SENSORS)		3/16" SS WELDED LINES (2)	1	No	\$410.

## 2.75" CF FLANGE FEEDTHRUS

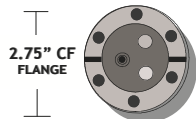

PART#	DESCRIPTION	DIAGRAM	H2O LINES	COAXIAL LINES	AIR SHUTTER LINE?	PRICE
ASC-FT1	SINGLE 2.75" FLANGE FEEDTHRU (USE WITH SINGLE SENSORS)		3/16" SS WELDED LINES (2)	1	No	\$505.
ASC-FT2	DUAL 2.75" FLANGE FEEDTHRU (USE WITH DUAL SENSORS)		3/16" SS WELDED LINES (2)	2	YES 3/16" SS	\$696.

## SENSOR HEAD SPARE PARTS

### CRYSTAL HOLDER CAP

\*FOR INFICON SENSOR HEADS-EXACT REPLACEMENT!



ASC-0172 \$85./EA.

### CRYSTAL SNATCHER TOOL FOR INFICON SENSOR HEAD



ASC-007 \$40./EA.

### FINGER SPRING CONTACT STRIP FOR INFICON SENSOR HEAD



ASC-FSCS \$35./EA.

### GROUNDING LEAF SPRING FOR INFICON 12 SENSOR HEAD



ASC-657 \$130./EA.

### SPRING FOR INFICON 12 & SPUTTERING SENSOR HEAD



ASC-626 \$45./EA.

### CERAMIC RETAINER FOR INFICON SENSOR HEADS



ASC-0123 \$72./EA.

### CERAMIC RETAINER FOR MAXTEK SENSOR HEADS



ASC-259 \$165./EA.

FIND MORE SENSOR PARTS AT  
[WWW.THINFILMSUPPLY.COM](http://WWW.THINFILMSUPPLY.COM)

# FILAMENTS & ION GUN PARTS

## E-BEAM GUN FILAMENTS

	<b>ASC-EB16</b> 5 TURN FILAMENT *REPLACES FILTECH EB5441 *REPLACES TELEMAR 273-0002-1	<b>\$50./</b> <b>PACK OF 5</b> *QUANTITY DISCOUNTS AVAILABLE
--	--	--

	<b>ASC-E75T</b> 7.5 TURN FILAMENT *REPLACES FILTECH EB6871 *REPLACES TELEMAR 273-0001-1	<b>\$48./</b> <b>PACK OF 5</b> *QUANTITY DISCOUNTS AVAILABLE
---	--	--

	<b>ASC-L75T</b> LEYBOLD EGUN FILAMENT (HPE6)	<b>\$153./</b> <b>PACK OF 5</b> *QUANTITY DISCOUNTS AVAILABLE
--	---	---

	<b>ASC-Z75T</b> ZEISS EGUN FILAMENT (ESV6)	<b>\$105./</b> <b>PACK OF 5</b> *QUANTITY DISCOUNTS AVAILABLE
---	---	---

## ION GUN (MARK I) FILAMENT

	<b>ASC-ION1</b> *REPLACES FILTECH IS30274 *REPLACES SATIS A7500800Q-131M	<b>\$23./</b> <b>PACK OF 5</b> *QUANTITY DISCOUNTS AVAILABLE
--	--	--

## ION GUN (MARK II) FILAMENT

	<b>ASC-ION2</b> *replaces FilTech IS16962 *replaces Satis A7500800Q-101M	<b>\$28./</b> <b>PACK OF 5</b> *QUANTITY DISCOUNTS AVAILABLE
---	--	--

## MARK I ANODE FOR ION SOURCE

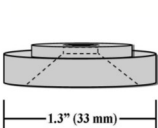
	<b>ASC-M1SA</b> STAINLESS STEEL ANODE	<b>\$60./EA</b>
	<b>ASC-M1GA</b> GRAPHITE ANODE	<b>\$70./EA</b>

1.3" (33 mm)

## MARK II ANODE FOR ION SOURCE

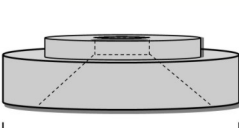
	<b>ASC-M2SA</b> STAINLESS STEEL ANODE	<b>\$90./EA</b>
	<b>ASC-M2GA</b> GRAPHITE ANODE	<b>\$160./EA</b>

2.7" (68.5 mm)

## MARK I GAS DISTRIBUTOR FOR ION

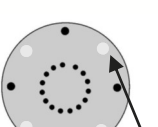
	<b>ASC-M1SGB</b> STAINLESS STEEL GAS DISTRIBUTOR	<b>\$105./EA</b>
	<b>ASC-M1GGB</b> GRAPHITE GAS DISTRIBUTOR	<b>\$255./EA</b>

1.3" (33 mm)

INCLUDES ADDED CERAMIC SPACERS (4) THAT REPLACE SAPPHIRE BALLS

## MARK II GAS DISTRIBUTOR FOR ION

	<b>ASC-M2SGB</b> STAINLESS STEEL GAS DISTRIBUTOR	<b>\$65./EA</b>
	<b>ASC-M2GGB</b> GRAPHITE GAS DISTRIBUTOR	<b>\$260./EA</b>

2.9" (75mm)

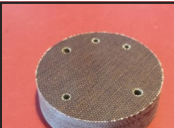
	<b>ASC-W-ION1</b> Mark I Work Station	<b>\$80./EA.</b>
--	--	------------------

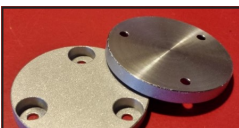
	<b>ASC-M2PSG</b> Mark II+ Gas Distributor	<b>\$115./EA.</b>
--	--	-------------------

## MARK I CATHODE SUPPORT

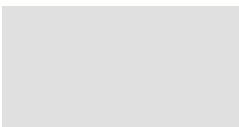
	<b>ASC-M1CS</b> MARK I CATHODE SUPPORT	<b>\$279./</b> <b>SET OF 2</b>
---	---	-----------------------------------

## MARK II CATHODE SUPPORT

	<b>ASC-M2CS</b> MARK II CATHODE SUPPORT	<b>\$150./</b> <b>SET OF 2</b>
--	--	-----------------------------------

## MARK I & MARK II INSULATOR

	<b>ASC-1032</b> MARK I & II INSULATOR	<b>\$16./</b> <b>2 PCS.</b>
--	--	--------------------------------

REGISTERED TRADE NAMES  
 BALZERS  
 CHA INDUSTRIES  
 CONVECTRON  
 INFICON  
 FILTECH  
 GRANVILLE-PHILLIPS  
 LEYBOLD  
 MAXTEK  
 SYCON INSTRUMENTS  
 SLOAN  
 TELEMAR  
 TEMESCAL  
 SATIS  
 SIGMA INSTRUMENTS  
 ULVAC  
 UMICORE  
 UNAXIS  
 ZEISS



# OPTINAL<sup>®</sup> THIN FILM SUPPLY.COM<sup>®</sup>

## EVAPORATION MATERIALS

CHOOSE YOUR FORM  
CALL TO REQUEST DIFFERENT FORM IF IT IS NOT LISTED



CHEMICAL & FORMULA	PART #	PURITY	GRANULE SIZES AVAILABLE	TABLET SIZES AVAILABLE	QTY	PRICE
SiO <sub>2</sub> (SILICON DIOXIDE) (LOW INDEX COMPOUND)	ASC-SIO2	99.99%	1-3MM, 3-5MM		1 KG.	\$65.
SiO (SILICON MONOXIDE)	ASC-SIO	99.9%	1-3MM, 3-5MM		1 KG.	\$98.
TiO <sub>2</sub> (TITANIUM DIOXIDE)	ASC-TIO2	99.9%	1-3MM, 3-5MM	8x6MM, 11x5MM	1 KG.	\$125.
TiO (TITANIUM II OXIDE)	ASC-TIO	99.9%	1-3MM		1 KG.	\$325.
Ti <sub>2</sub> O <sub>3</sub> (TITANIUM III OXIDE)	ASC-TI2O3	99.9%		10x8MM	1 KG.	\$520.
Ti <sub>3</sub> O <sub>5</sub> (TITANIUM V OXIDE)	ASC-TI3O5	99.95%	0.5-3MM	11x7MM	1 KG.	\$520.
AL <sub>2</sub> O <sub>3</sub> (ALUMINUM OXIDE)	ASC-AL2O3	99.99%	1-3MM, 3-5MM		1 KG.	\$312.
MgO (MAGNESIUM OXIDE)	ASC-MGO	99.9%	1-3MM		1 KG.	\$645.
MgF <sub>2</sub> (MAGNESIUM FLUORIDE)	ASC-MGF2	99.9%	.7-1.5MM, 1-3MM, 3-5MM		1 KG.	\$210.
HfO <sub>2</sub> WHITE (HAFNIUM OXIDE)	ASC-HFO2	99.99%	1-3MM	10x5MM	1 KG.	\$1125.
ZrO <sub>2</sub> (ZIRCONIUM DIOXIDE- WHITE)	ASC-ZRO2W	99.7%	1-3MM	13x6MM, 13x9MM, 15x7M 17.5x5MM 19x10MM, 21x7MM, 26x10MM	1 KG.	\$156.
ZrO <sub>2</sub> (ZIRCONIUM DIOXIDE-GRAY)	ASC-ZRO2B	99.7%	1-3MM	10x6MM, 12x6MM, 16x6MM 14x9 (ROUNDED PILL) 18x8MM (FLAT PILL)	1 KG.	\$338.
ZnS (ZINC SULFIDE)	ASC-ZNS	99.99%	3-6MM		1 KG.	\$156.
Y <sub>2</sub> O <sub>3</sub> (YTTRIUM OXIDE)	ASC-Y2O3	99.99%	3-6MM	8x6MM	1 KG.	\$620.
SnO <sub>2</sub> (TIN (IV) OXIDE)	ASC-SNO2	99%	1-2MM		1 KG.	\$430.
TA <sub>2</sub> O <sub>5</sub> (TANTALUM PENTOXIDE)	ASC-TA2O5	99.99%	1-3MM	15x8MM	1 KG.	\$980.
ITO (INDIUM TIN OXIDE) (90% In <sub>2</sub> O <sub>3</sub> , 10% SnO <sub>2</sub> )	ASC-ITO	99.99%	1-3MM	7x6MM	100 GRAM	\$225.
CHROMIUM	ASC-CRM	99.5%	.7-1.5MM, 1-3MM, 3-5MM		1 KG.	\$140.
CHROMIUM/SiO BLEND (ADHESION)	ASC-CRSIO	99.9%	1-3MM		1 KG.	\$420.

### STANDARD AND SUPER HYDROPHOBIC/OLEOPHOBIC TOP COAT TABLETS

STANDARD HYDROPHOBIC TOP COAT PILL	ASC-HYDRO2	CONTACT ANGLE= 100° - 105°		8x5MM WHITE TABLET	100 PILLS	\$150.
SUPER HYDROPHOBIC /OLEOPHOBIC TOP COAT PILL (STEEL WOOL PRESSED TABLET)	ASC-EZ04	CONTACT ANGLE= 110° - 120°		12x4MM TABLET	PER PILL	\$8./EA *QUANTITY DISCOUNTS AVAILABLE
SUPER HYDROPHOBIC /OLEOPHOBIC TOP COAT PILL (STEEL WOOL PRESSED TABLET IN CU CRUCIBLE)	ASC-EZC4	CONTACT ANGLE= 110° - 120°		16x6MM TABLET	PER PILL	\$8./EA *QUANTITY DISCOUNTS AVAILABLE
SUPER HYDROPHOBIC /OLEOPHOBIC TOP COAT PILL (STEEL WOOL PRESSED TABLET IN SS CRUCIBLE)	ASC-SZS4	CONTACT ANGLE= 110° - 120°		16x5MM TABLET	PER PILL	\$8./EA *QUANTITY DISCOUNTS AVAILABLE
SUPER HYDROPHOBIC /OLEOPHOBIC TOP COAT PILL (CERAMIC TYPE)	ASC-CT04	CONTACT ANGLE= 110° - 120°		12x4MM TABLET	PER PILL	\$8./EA *QUANTITY DISCOUNTS AVAILABLE